

Peter A. Pizzola,¹ M.S.; Steven Roth,² Ph.D.;
and Peter R. De Forest,² D.Crim.

Blood Droplet Dynamics—II

REFERENCE: Pizzola, P. A., Roth, S., and De Forest, P. R., "Blood Droplet Dynamics—II," *Journal of Forensic Sciences*, JFSCA, Vol. 31, No. 1, Jan. 1986, pp. 50-64.

ABSTRACT: An earlier companion paper to the present one dealt with a literature review as well as blood droplet formation and impacts to stationary target surfaces. The present paper discusses the results of experiments with moving target surfaces. These are discussed in the context of their correlation with blood droplet impacts to inclined stationary targets and with respect to the interpretation of bloodstain patterns at crime scenes where the target surface is capable of its own movement. A special belt device was designed and constructed for the experiments reported here. This motorized apparatus was used to drive paper belt target surfaces at various controlled speeds.

KEYWORDS: forensic science, blood, drops (liquids)

This study was conducted to determine whether or not the stains produced by blood drops falling vertically onto inclined surfaces are correlated with those produced by drops projected with a horizontal component falling and impacting horizontal surfaces. We felt that the topic had not been adequately addressed in the literature [1-6], although most earlier authors seemed to assume that the two situations were highly correlated. In connection with the present study, a new type of apparatus of considerable value for exploring the phenomena of blood droplet/solid surface impacts was designed and built.

To perform a study of this type, it is obviously necessary to maintain careful control over the vertical (V_y) and horizontal (V_x) components of velocity. Furthermore, it was essential that only single droplets of blood be produced for impaction. In the conventional sense, this is not easily accomplished. It is difficult to project drops of a known preselected volume horizontally with an accurately controlled velocity, although Adam et al have apparently done so in their study of "The Collision Coalescence, and Disruption of Water Droplets," using two droplet generators [7]. These devices consumed relatively large volumes of water to produce the desired number of very small droplets by electrostatically selecting them from a continuous stream of droplets. Although this scheme works well with water, it seems not to be a practical one for use with blood. In addition, the rather complex and expensive device designed by these investigators may not be suitable for the full range of drop sizes desired in blood studies. Thus, an alternate approach was investigated.

The material presented here is based on a thesis submitted by Peter A. Pizzola in partial fulfillment of the requirements for the Master of Science Degree in Forensic Science at John Jay College of Criminal Justice, The City University of New York. Presented at the 36th Annual Meeting of the American Academy of Forensic Sciences, Anaheim, CA, 21-25 Feb. 1984. Received for publication 4 April 1985; accepted for publication 30 May 1985.

¹Detective sergeant/laboratory director, Forensic Science Laboratory, Yonkers Police Department, Yonkers, NY.

²Assistant professor of science and professor of criminalistics, respectively, John Jay College of Criminal Justice, The City University of New York, New York, NY.

If a person runs with a pipet of blood and allows a drop to be released, it strikes the ground at some velocity and angle (measured from the tangent to the trajectory at contact). In a relativistic sense, if you suspend this person at his or her original position above ground, and allow a drop of blood to be released from the pipet while the ground is moving in a direction opposite to his or her original motion, an equivalent situation is obtained, although, in the first situation, the viscosity of air would be expected to exert a decelerating influence such that the horizontal component at impact would be less than at release. For relatively large droplets and low horizontal components of velocity, this effect would be minimal. The latter situation, where the horizontal component is unaffected by the viscosity of air, is replicated by using the moving belt device. Another advantage to this arrangement, where blood droplets are released from a pipet and allowed to impact the horizontally moving belt, is that the problem of projecting single droplets of a constant known size and known velocity is obviated.

Methods and Materials

For the purposes of this study, a moving belt device was constructed (see Figs. 1-4). Both spools are made of polished aluminum and are of the self-centering type to keep the paper belt in position when it is running. The driven spool has a hollow core, while the drive spool has a solid core, enabling the former to spin freely when the paper is driven. The spools run $\pm 5 \mu\text{m}$ (0.0002 in.) concentric to the bearing holes. Both axles and towers are made of carbon steel while the bearings are stainless steel. The coupling of the drive motor to the drive spool is via a round rubber drive belt to reduce vibration. For ordinary operation the tower section is removed from the main base and placed on another heavy base to allow an increase in the belt length. As can be seen in the accompanying photographs, there are adjustments on each tower to aid in the tightening and alignment of the paper belt. Additionally, the height of the driven spool can be varied by turning thumbscrews on the axle ends. The supports for the driven spool can be unlocked or locked by turning thumbscrews on the axle ends. The speed of the belt can be varied with the aid of a variable transformer connected to the 5000 rpm universal motor.

A typical belt is made by taking adding machine or integrator paper (6.35 cm in width), looping it around the spools, and cutting an appropriate length to permit several centimetres of

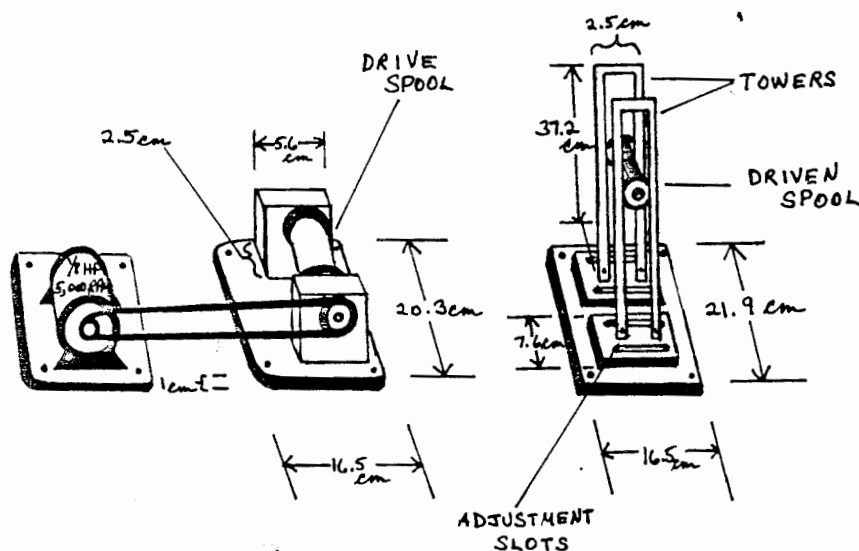

FIG. 1—Moving belt device.

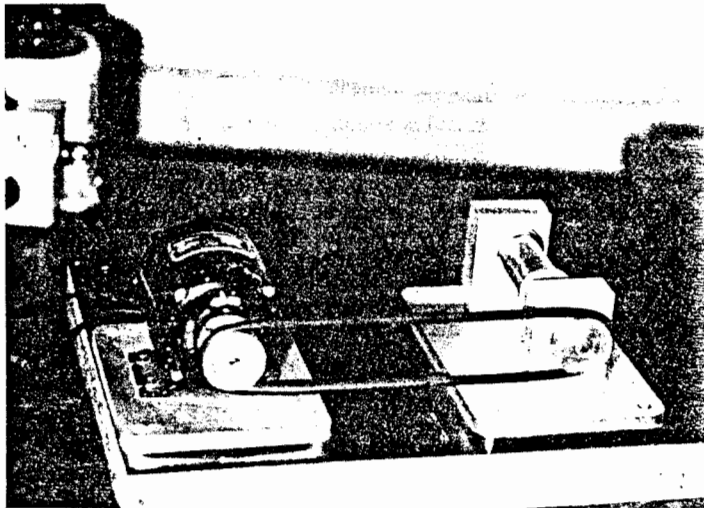

FIG. 2—Drive spool and motor (1/8 hp, 5000 rpm). (1 hp = 746 W).

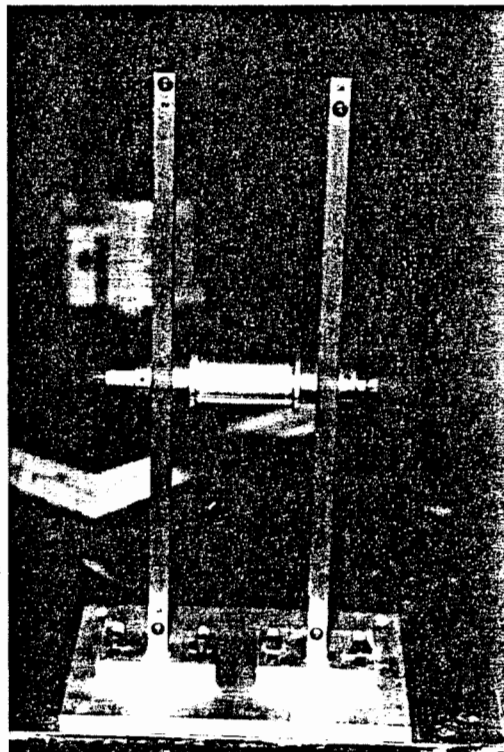

FIG. 3—Driven spool section.

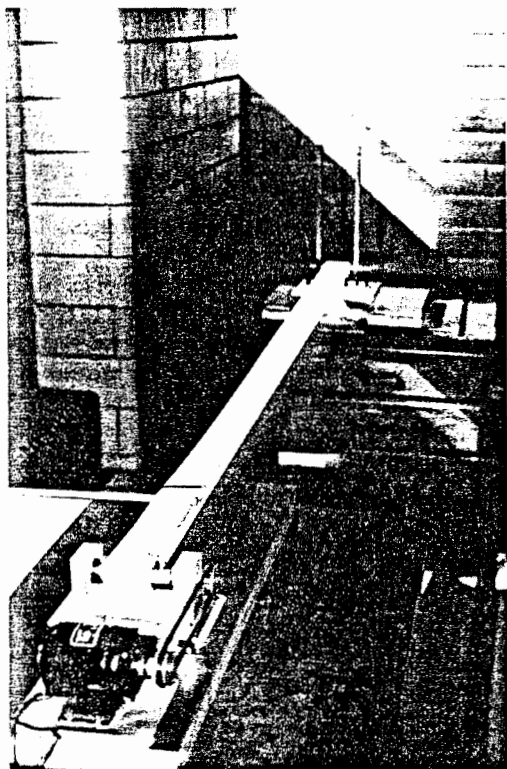

FIG. 4—Belt device in operation.

overlap. After the overlapping paper is properly aligned, it is taped together with transparent tape and the excess paper is removed. Interposed between the upper and lower portions of the belt, about 30 cm from the drive spool, is a steel laboratory rod positioned up against the lower surface of the upper part of the loop. This serves to keep the impact area of the belt reasonably taut, level, and vibration free. For ordinary operation, when the spools are placed about 2 m (6 or 7 ft) apart, the sections are aligned with the aid of a steel straight edge (approximately 3 mm by 5 cm by 2.4 m).

Timing is accomplished by placing a large black index mark across the paper, near the transparent tape, and counting the number of times it passes a fixed point during a time span of ten seconds. If the belt velocity is too high for counting the revolutions visually, a distinctive noise that occurs every time the taped area of the belt passes the steel rod can be used for counting. Just before a trial, the total length of the paper loop is estimated. At least ten revolutions are used for calculating the velocity. To ensure that the belt is running in a stable manner, three timings are conducted before the impacts are allowed to occur. These are repeated once after the experiment is completed. Subsequently, the belt is removed and the length is determined more exactly so that the average velocity can be accurately calculated.

The blood was allowed to drop from a pasteur pipet equipped with a rubber bulb at a height of 14 cm above the belt. All blood samples were warmed to 37°C before use. The blood for the moving belt correlation study was freshly drawn on the day of each experiment and contained heparin as an anti-clotting agent. Initially, a low velocity was chosen since it was believed that the velocity caused by the vertical fall could be accurately determined from:

$$V^2 = V_0^2 + 2as \quad (1)$$

assuming that the effect of air resistance at this height of fall would be negligible. If the drop is released gently, it will generally have a velocity slightly less than that predicted by the equation for rectilinear motion (about 2% less than the velocity in a vacuum for this dropping height). This was determined by high speed stroboscopic photography. Figure 5 illustrates the photographic equipment in the darkroom. The velocity at a dropping height of 14 cm was determined by high-speed, multiple flash stroboscopic photography.

The conditions that were optimum for obtaining the high-speed stroboscopic photographs were as follows: The stroboscope (General Radio Co. Strobotac, Model 1531-A) was situated approximately 10 cm from the pasteur pipet which was used to release the blood drop. It was laterally displaced at an angle of about 45° relative to the camera lens axis. This short lamp-to-subject distance was required since the energy per flash was rather low. The background, placed about 80 cm from the pipet, was a nonreflective black cloth. The camera used was a Yashica 35-mm SLR equipped with a Tamron macro lens (f-2.5, 90-mm focal length). The lens aperture was set at its widest opening. The lens to pipet distance was 25 cm. Various flashing rates were employed: 12, 16, and 24 kf/m (thousand flashes per minute). Kodak Tri-X (ASA 400) black-and-white film (developed for 8.5 min in D-76 full strength) was used. The shutter was set in the bulb position. When the drop was released (the stroboscope was already flashing), the shutter was opened. After the drop passed through the field of view, the shutter was closed.

The velocity was calculated from each negative frame utilizing a stereomicroscope at $\times 10$ in conjunction with a vernier caliper. For example, in Fig. 6 the distance between two successive images on the film is 1.70 mm. In most cases the distance between the images was measured from the lamp reflection highlight on each drop image. In so doing some error would be expected to be introduced into the calculations. However, the limited intensity of the stroboscope used resulted in poorly delineated air/drop boundary images in the negatives. Ideally, the distance should be measured from the top of an image to the top of another image. However, in this case, because of the indistinct boundary in the images, it was felt that this technique would result in more error than the former method.

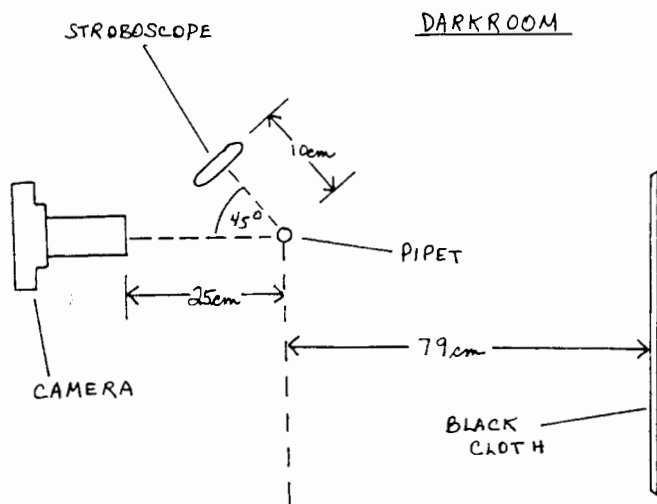

FIG. 5—Photographic equipment in the darkroom.

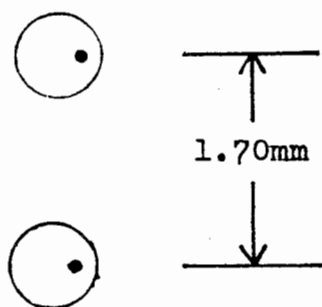

FIG. 6—The distance between two successive images on the film is 1.70 mm.

Results

The velocity of the falling droplet was calculated and compared in two somewhat different situations. In the first, the blood drop was released from the pasteur pipet with the aid of a rubber bulb. In the second situation, the drop of blood was released from a pasteur pipet tip attached to the petcock of a glass chromatographic column (1-cm inside diameter) shortened to about 2 cm. This was done to ascertain whether the velocity was significantly greater in the situation where the blood drop is gently released from a pipet equipped with a rubber bulb, as opposed to the situation where it is permitted to form and drip freely from a column. In both situations the drop sizes were found to be equivalent (approximately $26 \mu\text{L}$), and drop shape oscil-

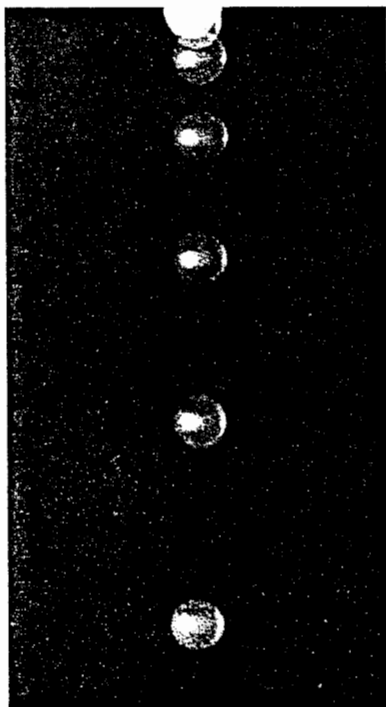

FIG. 7—High-speed stroboscopic photograph of a blood drop falling in air (approximate drop volume is $26 \mu\text{L}$).

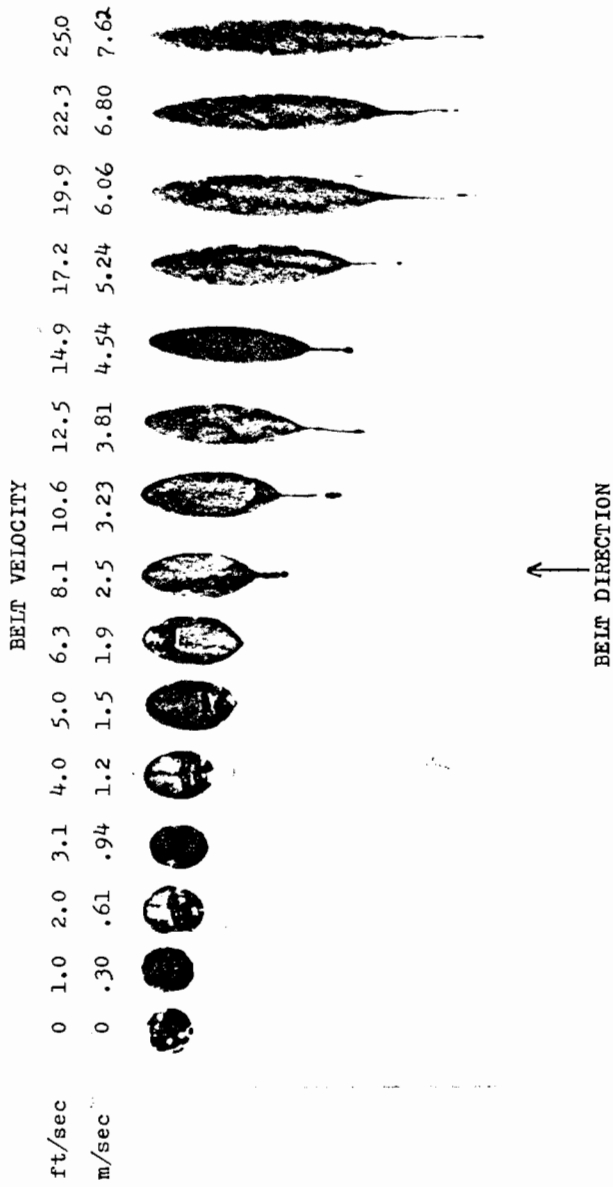

FIG. 8—Blood drop impacts with the belt moving horizontally with the height of the fall being 14 cm. (Stains were originally actual size.)

lations were noted which can be observed in Fig. 7. It was apparent that the characteristics of the pipet tip were the major factors in establishing the drop size.

Nine separate determinations were done for the situation where the blood drop was released from a pasteur pipet utilizing a rubber bulb. The mean of these determinations was 1.62 m/s (5.32 ft/s). The standard deviation was found to be 0.0491 m/s (0.161 ft/s). In the other situation, with the pipet tip attached to the column, the mean velocity was found to be 1.62 m/s (5.32 ft/s), based on eleven determinations. The standard deviation was 0.0579 m/s (0.190 ft/s). Thus the velocity in the two situations is approximately the same. The velocity at this short dropping height closely matches that calculated for blood falling from the same height in a vacuum. From Eq 1, the velocity in a vacuum is 1.65 m/s (5.41 ft/s). As would be expected at this short dropping distance, the velocity of the drop was not significantly affected by air resistance.

The drop sizes were confirmed as approximately 26 μ L by measurements taken from high-speed single flash photographs [8]. Blood was dropped onto paper belts running at various speeds while the dropping height was kept constant. The stains are shown in Fig. 8. See Table 1 for stain dimensions with corresponding belt speeds and major diameter (D or length) to minor diameter (d or width) ratios.

For a drop falling vertically onto a moving belt, an *effective angle of incidence* (EAI) can be envisioned. This corresponds to the angle of incidence described for drops falling vertically onto inclined stationary targets. Figure 9 illustrates the angle that will be discussed. In this figure, for example, it is the 60° angle (measured from the surface normal). Blood drops were allowed to fall onto stationary inclined surfaces from a height of 14 cm. The surface was the same paper substrate that was used for the belt trials (see Fig. 10).

Figure 11 shows how the EAI is calculated from the arc tangent of the ratio of the horizontal component of the velocity to its vertical component. Table 2 shows the angle discussed with the corresponding ratios and belt velocities.

Discussion and Conclusions

An examination of the similarity between the graphs (Fig. 12) representing the D/d ratio versus EAI and the D/d ratio versus the stationary angle of incidence shows that impacts of drops of blood on inclined surfaces are correlated with those on moving belts. Since the latter

TABLE 1—Stain dimensions with corresponding belt speeds and major diameter (D) to minor diameter (d) ratios.

V_x , m/s	V_x , ft/s	Mean d , mm ^a	Mean D , mm ^a	Mean D/d
7.62	25.0	7.9	52.0	6.6
6.80	22.3	7.9	44.7	5.6
6.06	19.9	8.7	44.5	5.1
5.24	17.2	8.2	38.8	4.7
4.54	14.9	8.0	33.0	4.1
3.81	12.5	8.9	30.7	3.4
3.23	10.6	9.0	27.2	3.0
2.5	8.1	9.6	21.8	2.3
1.9	6.3	9.7	18.7	1.9
1.5	5.0	9.4	16.8	1.8
1.2	4.0	9.0	14.1	1.6
0.94	3.1	9.0	12.0	1.3
0.61	2.0	10.1	12.0	1.2
0.30	1.0	9.7	10.3	1.1
0	0	9.0	9.0	1.0

^aMean is based on nine determinations at each velocity.

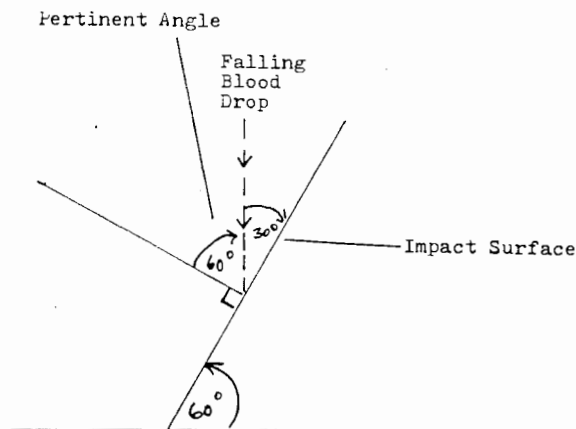

FIG. 9— 60° angle of incidence (measured from the surface normal).

situation can be regarded as an example of Newtonian relativity, it can be concluded that the stains produced by blood drops projected horizontally are correlated with those from drops falling vertically onto inclined surfaces. A careful examination of the stains generated in each situation indicates some differences with regard to their size. That is, larger stains appear to have been produced in the moving belt situation. This is because although the general situations are equivalent, the conditions used are not. If one desires to observe an exactly equivalent situation, it is necessary that the drops impacting inclined surfaces be allowed to fall from higher points so that the resultant vector of velocity is equivalent in magnitude to the moving belt situation (see Fig. 13). Figure 14 clearly demonstrates the difference obtained in stain patterns when the horizontal component of velocity is kept constant while the vertical component is varied.

Of considerable importance to actual interpretations is the possibility that the appearance of the bloodstain is a result of the motion of the substrate at the moment of impact of the drop of blood. If the target surface is capable of its own motion, and one does not know with a reasonable degree of certainty that the target was motionless at the time of impact, it is risky to interpret the bloodstain with regard to its directionality and angle of incidence. While this statement may seem obvious to some, this fact appears not to have been explicitly recognized by many workers. This factor has particular implications for stains on human skin [9]. Photographs of stains produced by blood impacting fixed and moving skin surfaces are presented in Fig. 15.

Note, in addition to what has already been shown, how a stain is affected by the motion of a target which is presented to a moving drop at an angle with respect to its direction of travel. For one set of experiments the apparatus was inclined as shown in Fig. 16. In the stains shown in Fig. 17, one can see how successive drop patterns change from an elongated stain to a circle and, finally, to a reversed elongated stain as the belt velocity is increased in a downhill direction while the dropping height is held constant.

The drop volume (approximately $26 \mu\text{L}$) was calculated from measurements taken from single flash photographs of individual falling droplets as reported in part one of this study [8]. The effect of changing one velocity component while the other component is kept constant is illustrated. Work with this device calls attention to possible errors in interpreting stains present on targets that are capable of their own motion. Stains on movable surfaces should be interpreted with an extra measure of caution unless it is known that the surface was fixed at the time the stain or stains were created. Thus, in crime scene work, situations where the target was moving or where both the source and target were moving may not be interpretable.

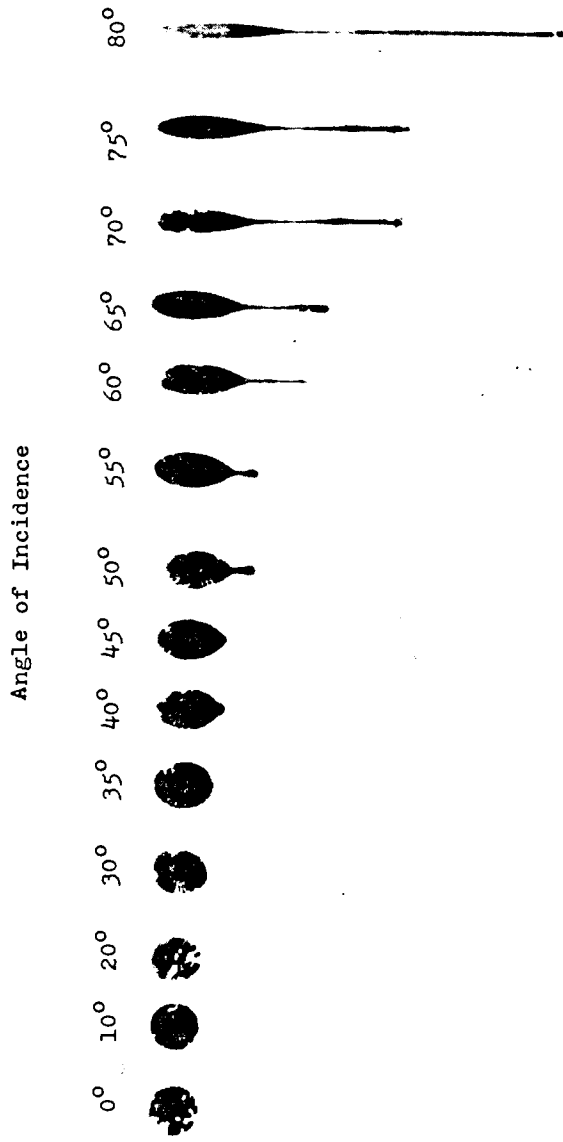

FIG. 10—Blood drop impacts with stationary inclined surfaces with the height of the fall being 14 cm. (Stains were originally actual size.)

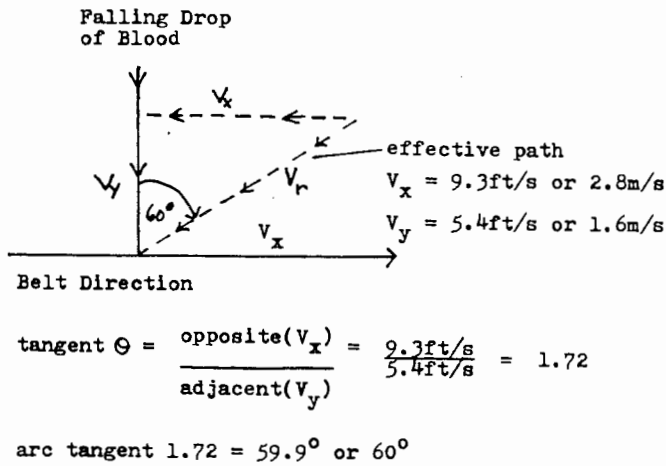

FIG. 11—Calculation of EAI from the arc tangent of the ratio of the horizontal component of the velocity to its vertical component.

TABLE 2—Angle discussed with the corresponding ratios and belt velocities.

V_x , m/s	V_x , ft/s	Mean D/d	EAI
7.62	25.0	6.6	77.8°
6.80	22.3	5.6	76.4°
6.06	19.9	5.1	74.8°
5.24	17.2	4.7	72.5°
4.54	14.9	4.1	70.0°
3.81	12.5	3.4	66.6°
3.23	10.6	3.0	63.0°
2.5	8.1	2.3	56°
1.9	6.3	1.9	49°
1.5	5.0	1.8	43°
1.2	4.0	1.6	36°
0.94	3.1	1.3	30°
0.61	2.0	1.2	20°
0.30	1.0	1.1	10°

The potential uses of the belt device extend beyond those discussed here. For example, the vertical component of velocity of falling blood drops can be determined from resulting stain patterns. This offers an alternative means of making determinations of terminal velocity. This device may also be useful for teaching and research in other physics or fluid dynamics contexts.

Summary

The equivalence of stain patterns left by drops projected with a horizontal component of velocity impacting horizontal surfaces and those left by drops falling vertically onto inclined surfaces has been demonstrated by a new technique which incorporates a moving belt device. This device allows the experimenter to control carefully the horizontal component of velocity, while the vertical component is controlled via the dropping height. The vertical component of velocity for the dropping height used in this study was determined via high-speed stroboscopic pho-

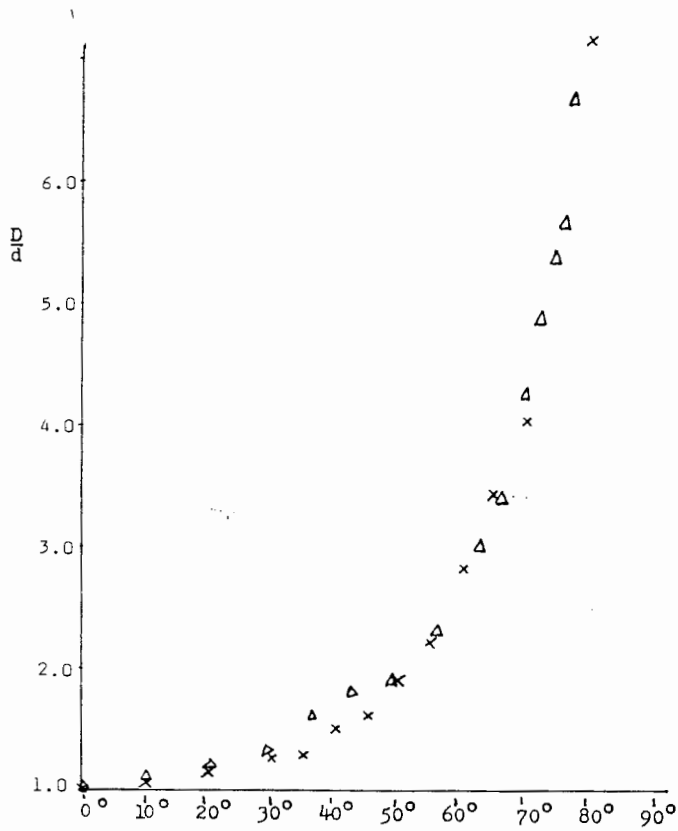

FIG. 12—The D/d ratio versus EAI and the D/d ratio versus the stationary angle of incidence where Δ = "effective" angle data points and X = stationary angle data points.

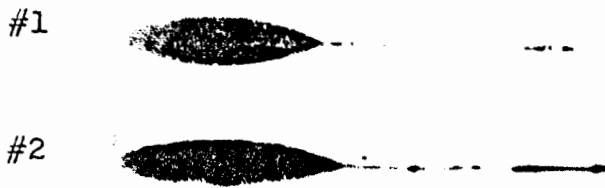

FIG. 13—Blood drop impacts where #1 fell 56.6 cm (22.3 in.) onto target inclined at 70° from the normal to the surface with a stationary target and #2 fell 4.45 cm (1.75 in.) onto belt target moving horizontally at 3.0 m/s (9.7 ft/s). (Stains are actual size.)

#1



#2



FIG. 14—Blood drop impacts where #1 fell 14 cm (5.5 in.) onto belt moving horizontally at 6.06 m/s (19.9 ft/s) and #2 fell 1.8 m (6 ft) onto belt moving horizontally at 6.1 m/s (20 ft/s). (Stains are actual size.)

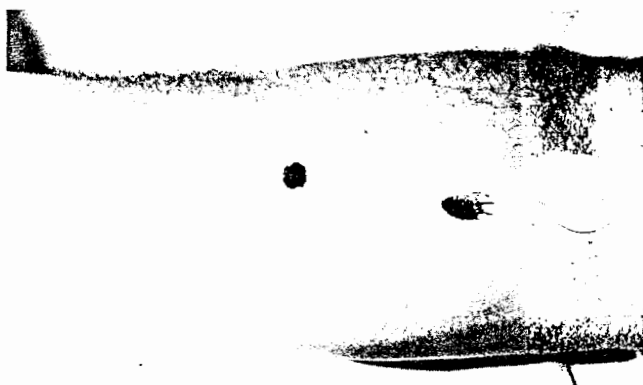

FIG. 15—Stains produced by blood impacting fixed and moving skin surfaces.

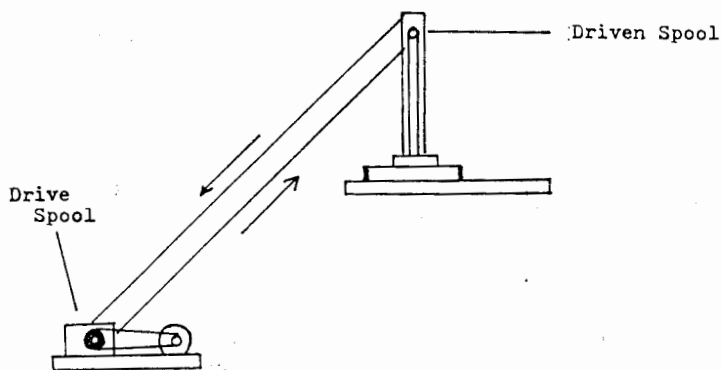

FIG. 16—Downhill orientation of belt device.

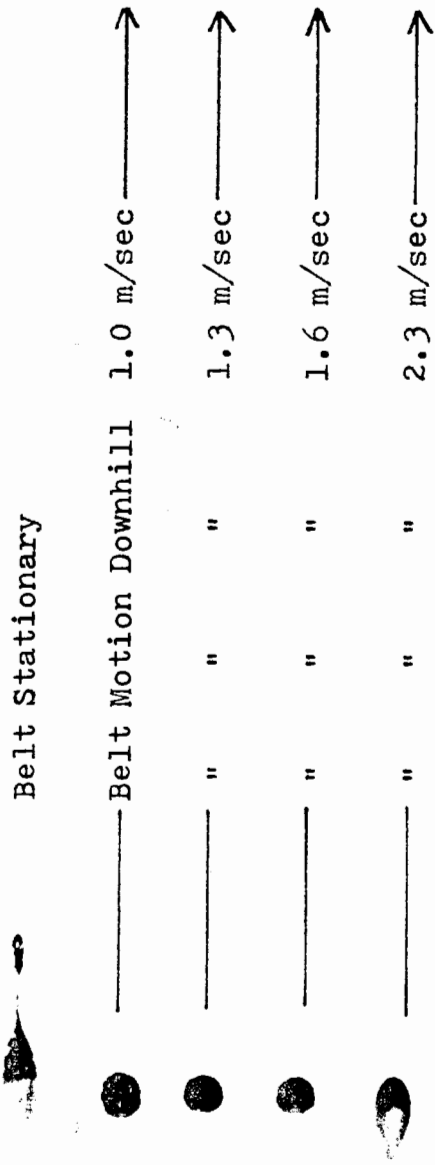

FIG. 17—Blood drop impacts with an influence of belt motion on resulting stain pattern with a dropping height of 14 cm (5.5 in.) and an angle of incidence 60°. (Stains are actual size.)

tography. Other uses of the belt device such as the determination of the instantaneous velocity of a falling blood drop have been proposed.

Acknowledgments

The authors are indebted to Timothy Carron for his skillful fabrication of the belt device which made this study possible. Further, we thank John Perkins of the Yonkers Police Department Forensic Science Laboratory for his advice with respect to the design of the belt device and for his help throughout the course of the study. We also acknowledge the kindness of Joseph Cagner of the Bronx Community College/CUNY for allowing us to have access to the stroboscope. Other colleagues to whom we are indebted for assistance of various kinds include Fredrick Drummond, Robert Adamo, Michael Lyons, Lenore Kodet, Jim Sumka, Alexander Hatzis, and John Zygmundt.

References

- [1] Gross, H., *Kriminalistische Tätigkeit Und Stellung Des Arztes*, Branmuller, Win and Leipzig, 1908.
- [2] Balthazard, V., Piedelievre, R., Desoille, H., and Derobert, L., "Etude des Gouttes de Sang Projete," *Annales Medecine Legale De Criminologie Police Scientifique, Medecene Sociale, et Toxicologie*, Vol. 19, No. 4, 1939, pp. 265-323.
- [3] Kirk, P. L., *Crime Investigation*, Interscience Publishers, New York, 1953, pp. 176-180.
- [4] MacDonell, H. L. and Bialousz, L. F., "Flight Characteristics and Stain Patterns of Human Blood," U.S. Department of Justice, Law Enforcement Assistance Administration, Washington, DC, 1971.
- [5] MacDonell, H. L., "Interpretation of Bloodstains: Physical Considerations," *Legal Medicine Annual*, 1971, C. Wecht, Ed., Appleton-Century Crofts, New York, 1971.
- [6] Laber, T. L. and Epstein, B. P., *Bloodstain Pattern Analysis*, Callen Publishing, Inc., Minneapolis, MN, 1983.
- [7] Adam, J. R., Lindblad, N. R., and Hendricks, C. D., "The Collision, Coalescence, and Distribution of Water Droplets," *Journal of Applied Physics*, Vol. 39, No. 11, Oct. 1968, pp. 5173-5180.
- [8] Pizzola, P. A., Roth, S. D., and De Forest, P. R., "Blood Droplet Dynamics—I," *Journal of Forensic Sciences*, Vol. 31, No. 1, Jan. 1986, pp. 000-000.
- [9] MacDonell, H. L. and Panchou, C. G., "Bloodstain Patterns on Human Skin," *Journal of the Canadian Society of Forensic Science*, Vol. 12, No. 3, Sept. 1979, pp. 134-141.

Address requests for reprints or additional information to
 Peter A. Pizzola
 Forensic Science Laboratory
 Yonkers Police Department
 87 Nepperhan Ave.
 Yonkers, NY 10701